

1. We recommend dismantling the tailgate before installing the spoiler. Cover the mounting insert with tape around the edge.

2. Cut the tape so that it does not protrude beyond the edge of the mounting insert.

3. Remove the tape from the mounting insert and stick it on the bottom side of the tailgate. The edge of the tape should be flush with the edge of the side projection of the tailgate.

4. Cut the hole indicated by the tape.

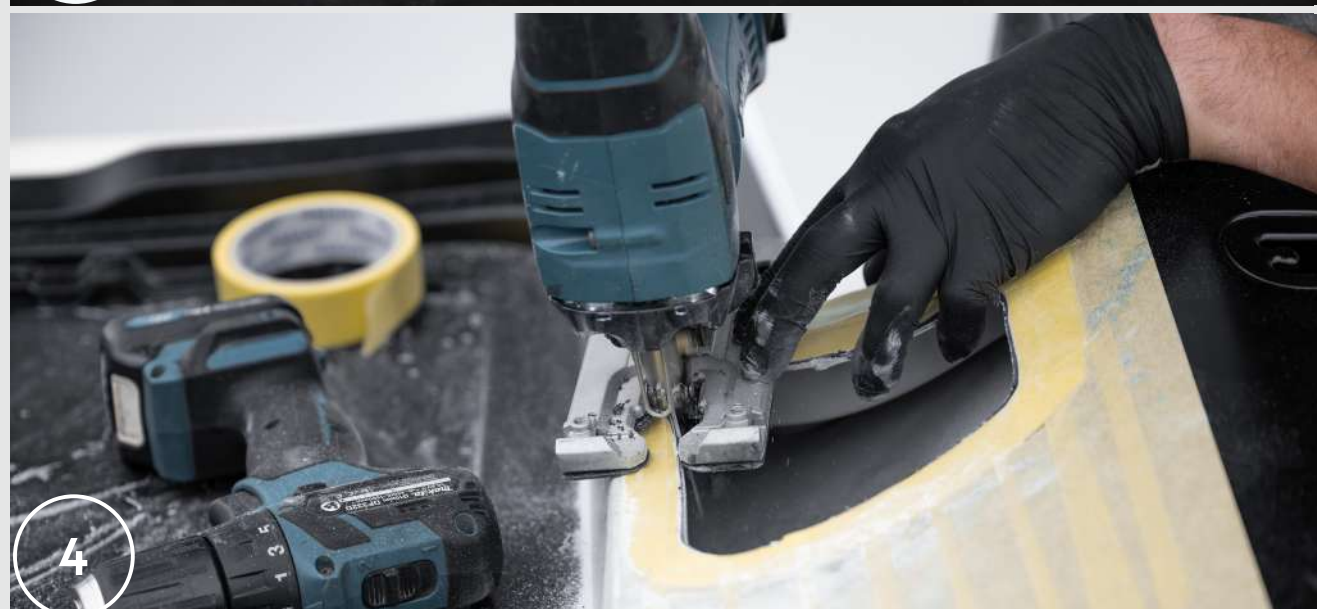
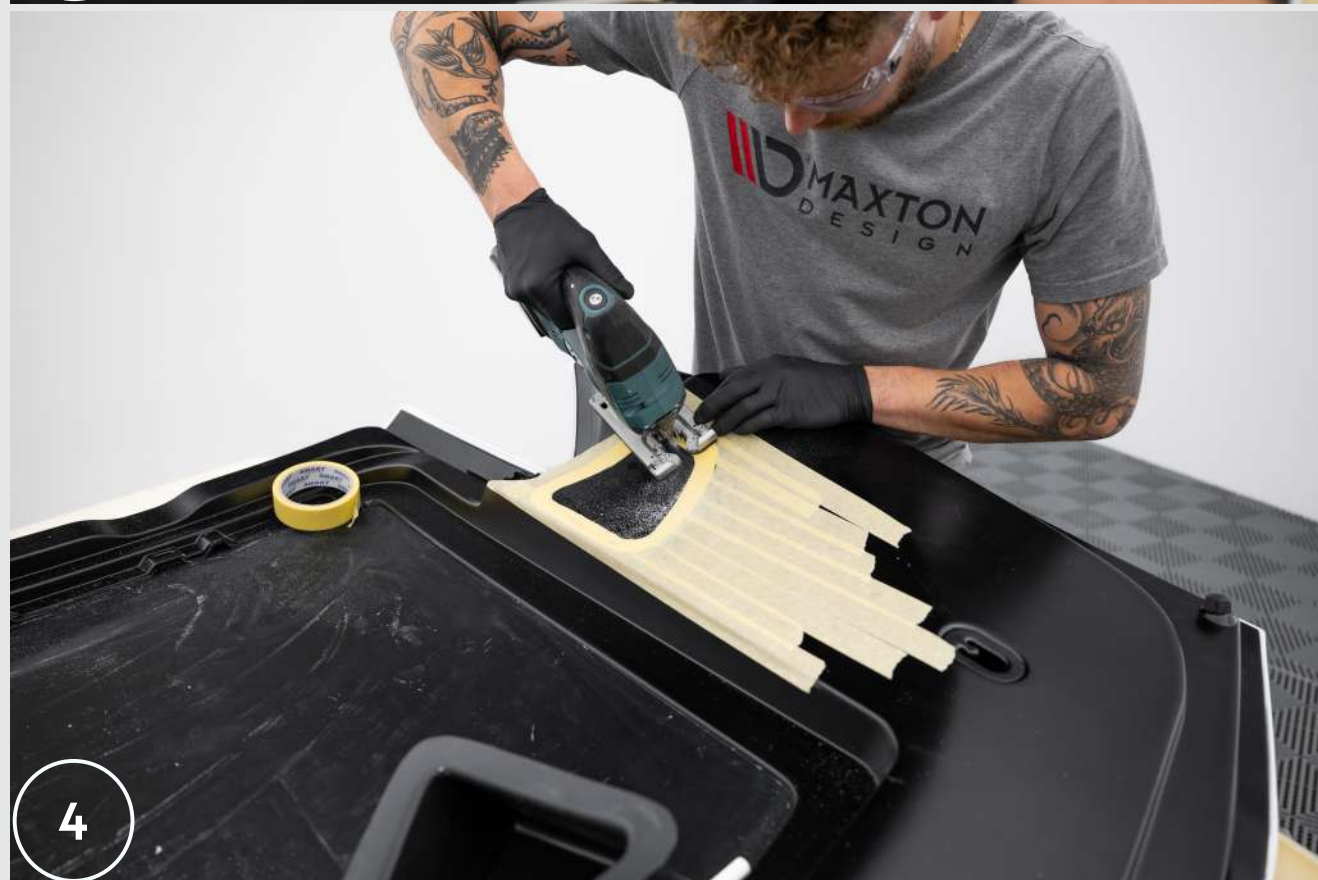





5. Prepare the rivets.

6. Insert the mounting insert into the cut-out hole and mark several points on its edge that will be riveted (we recommend 6 - 8 points).

7. Drill the holes according to the marked points.

8. Rivet the mounting insert to the tailgate. Repeat this operation on the other side of the tailgate.





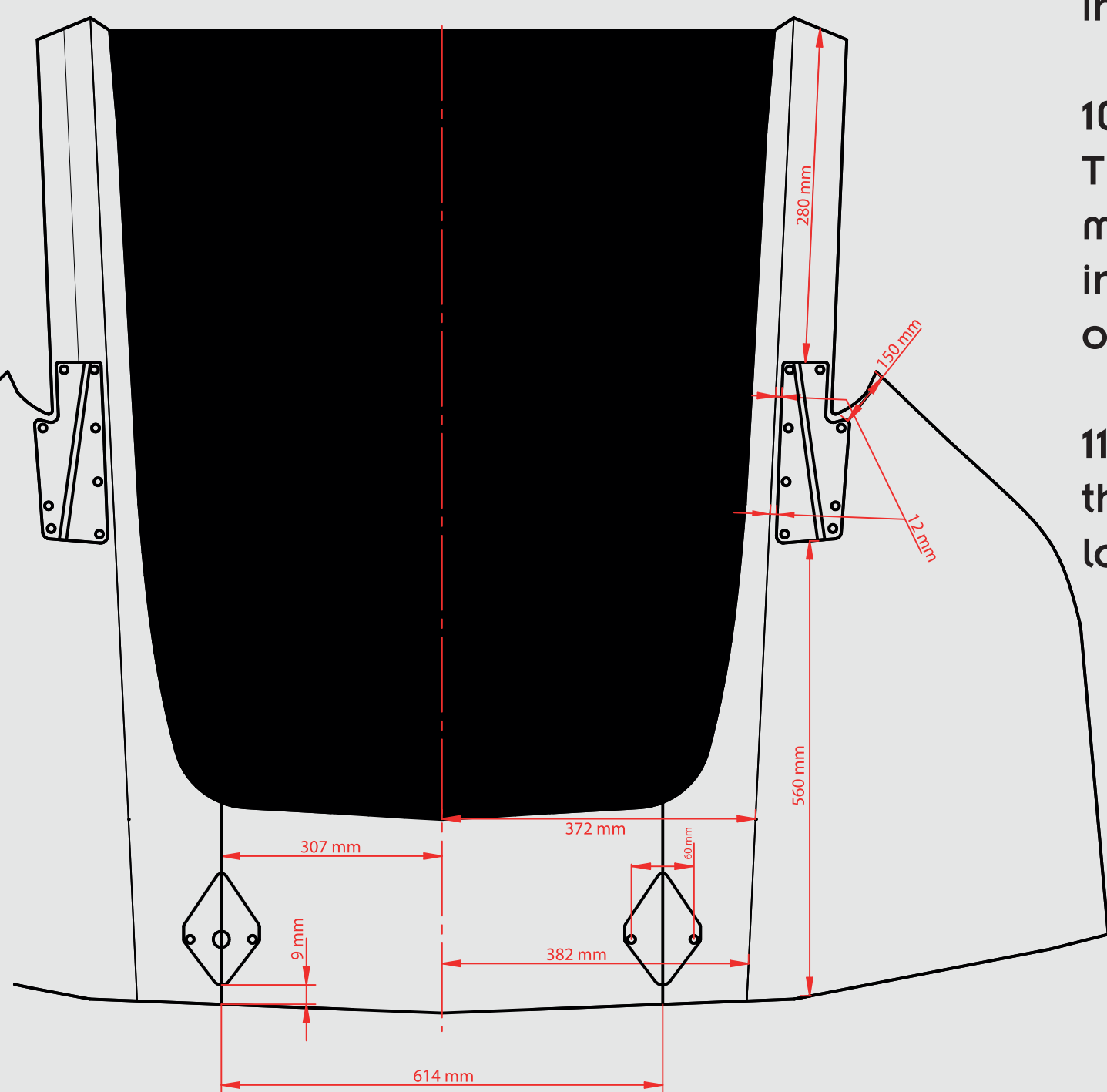

9. Secure the tailgate from above in the indicated place using tape.

10. Place the carbon mount on the tailgate. Then, using the drawing, arrange the carbon mount so that it matches the dimensions indicated (a larger drawing is on the last page of the instructions).

11. Once you have determined the position of the carbon mount, mark the mounting holes locations on the tape.







12



12



12

12. Drill holes in the marked locations.

13. In the locations where the holes were made outside the mounting insert, use a hole saw to enlarge the holes from the bottom.

14. Place protective tape on the back of the tailgate.

15. Using the drawing, mark the center of the tailgate and the lines in the locations where the spoiler brackets will be mounted.



13



14



15

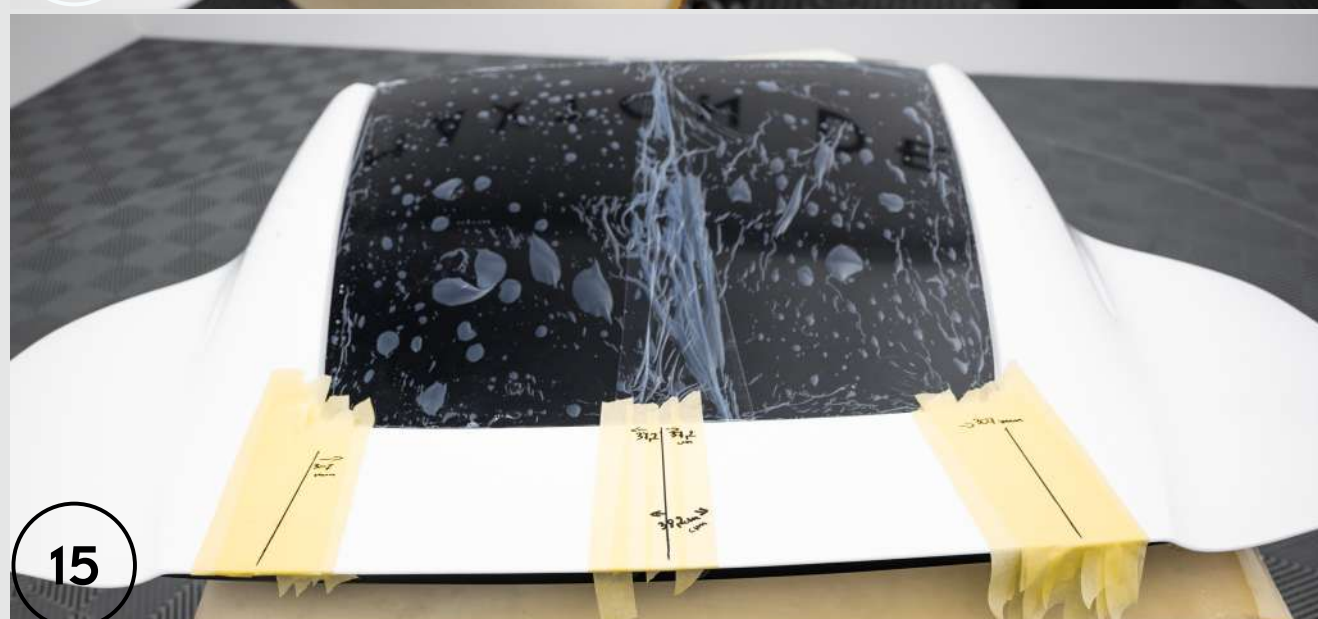

15



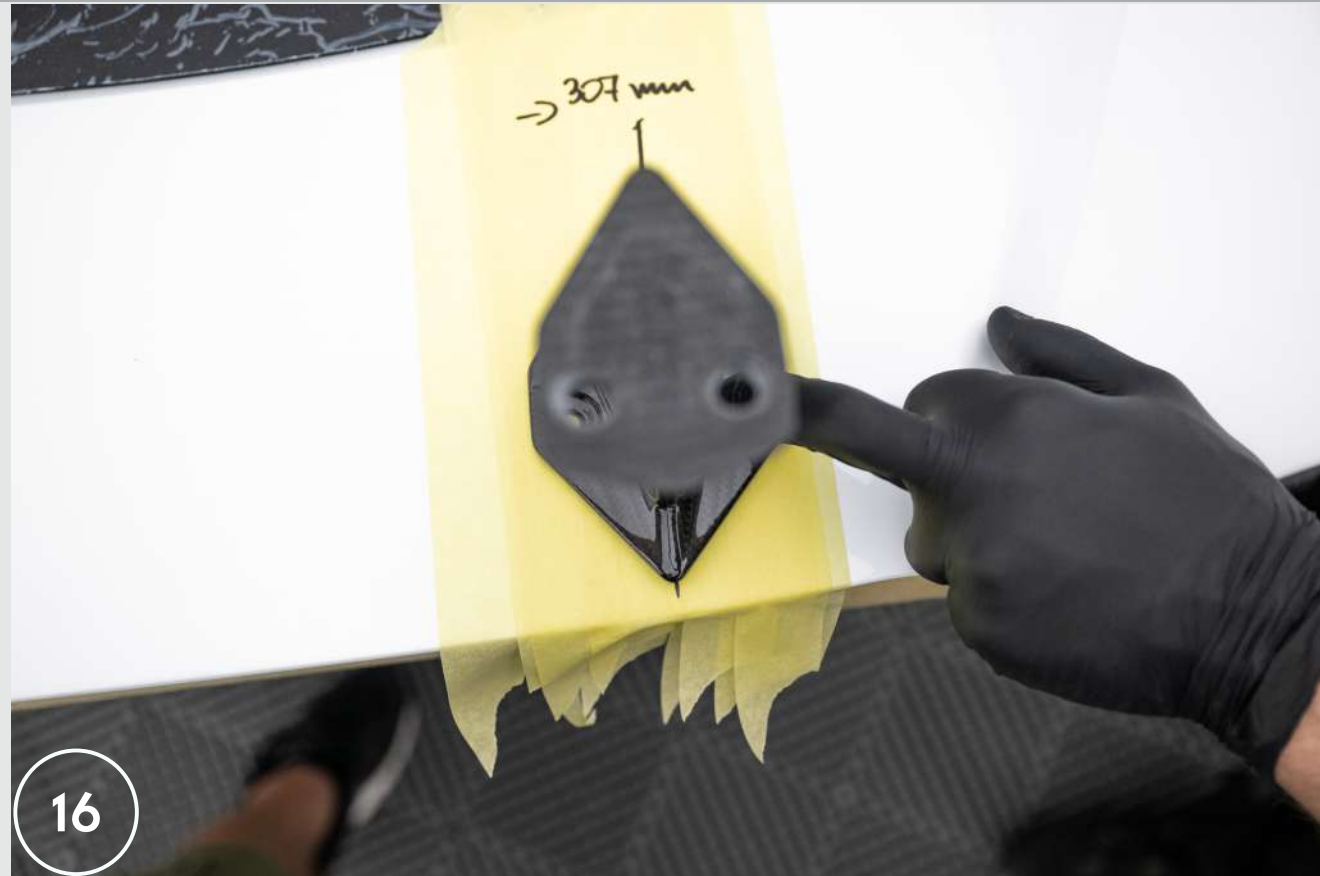

16

16. Place the spoiler brackets on the marked lines so that the line marks the bracket axis. Mark the mounting hole locations.

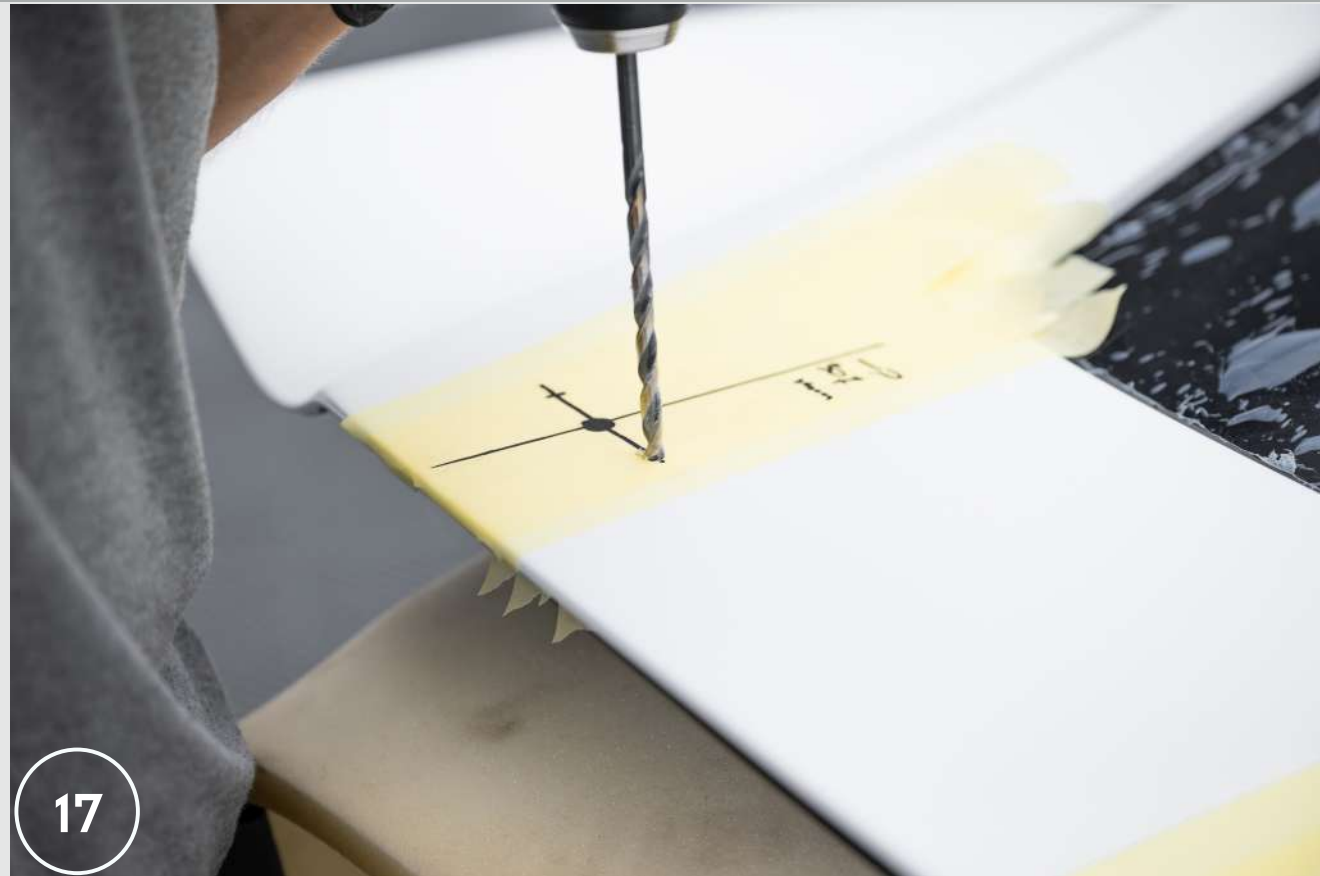

17

17. Drill holes in the marked locations. Make an additional hole on the left side in the very center of the axis - a hole for attaching the LED power cable.

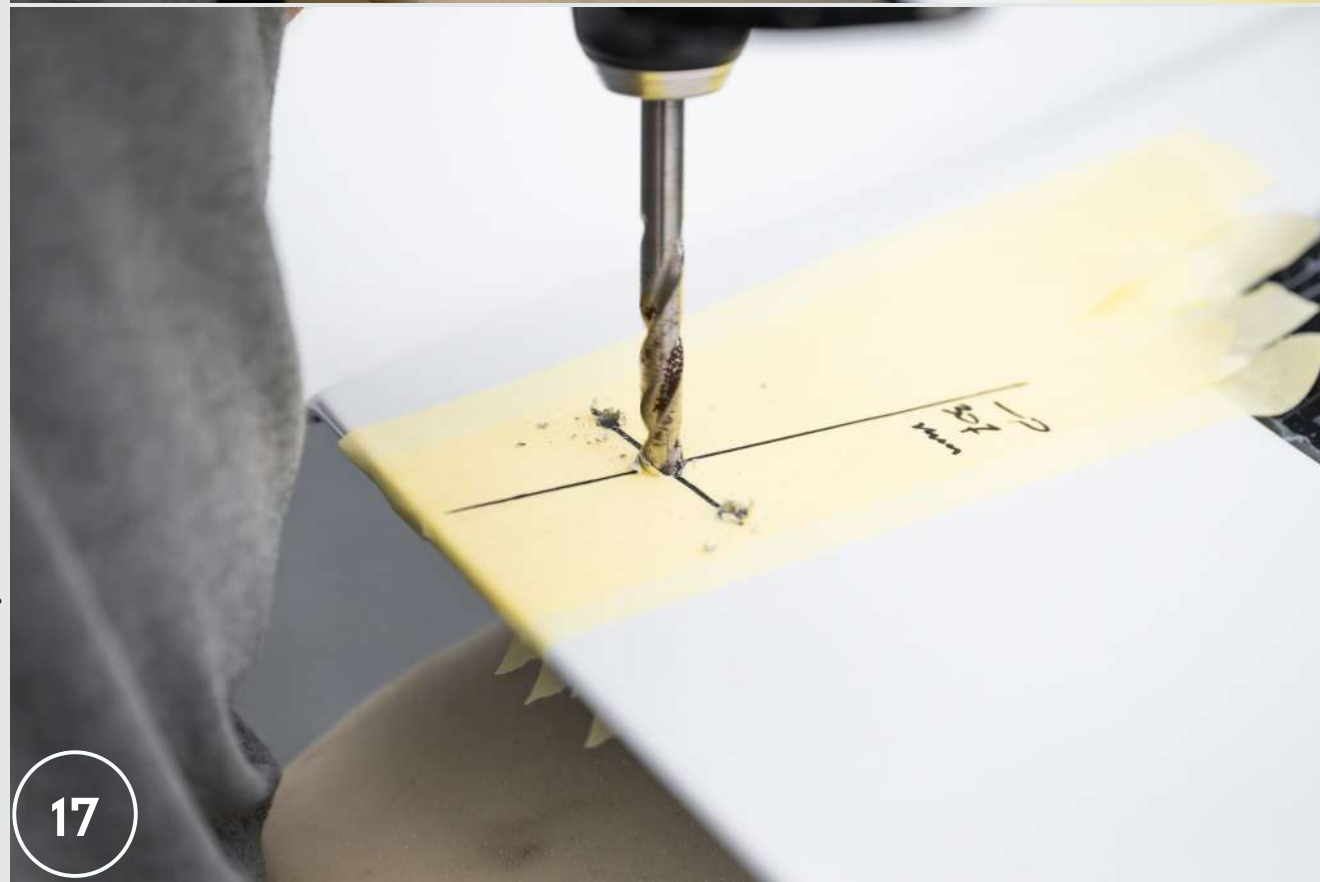

17

18. Mark the distance between the spoiler bracket mounting holes and transfer it to the edge of the tailgate.

19. Drill holes in the marked places.

20. Apply glue to the underside of the carbon mount.

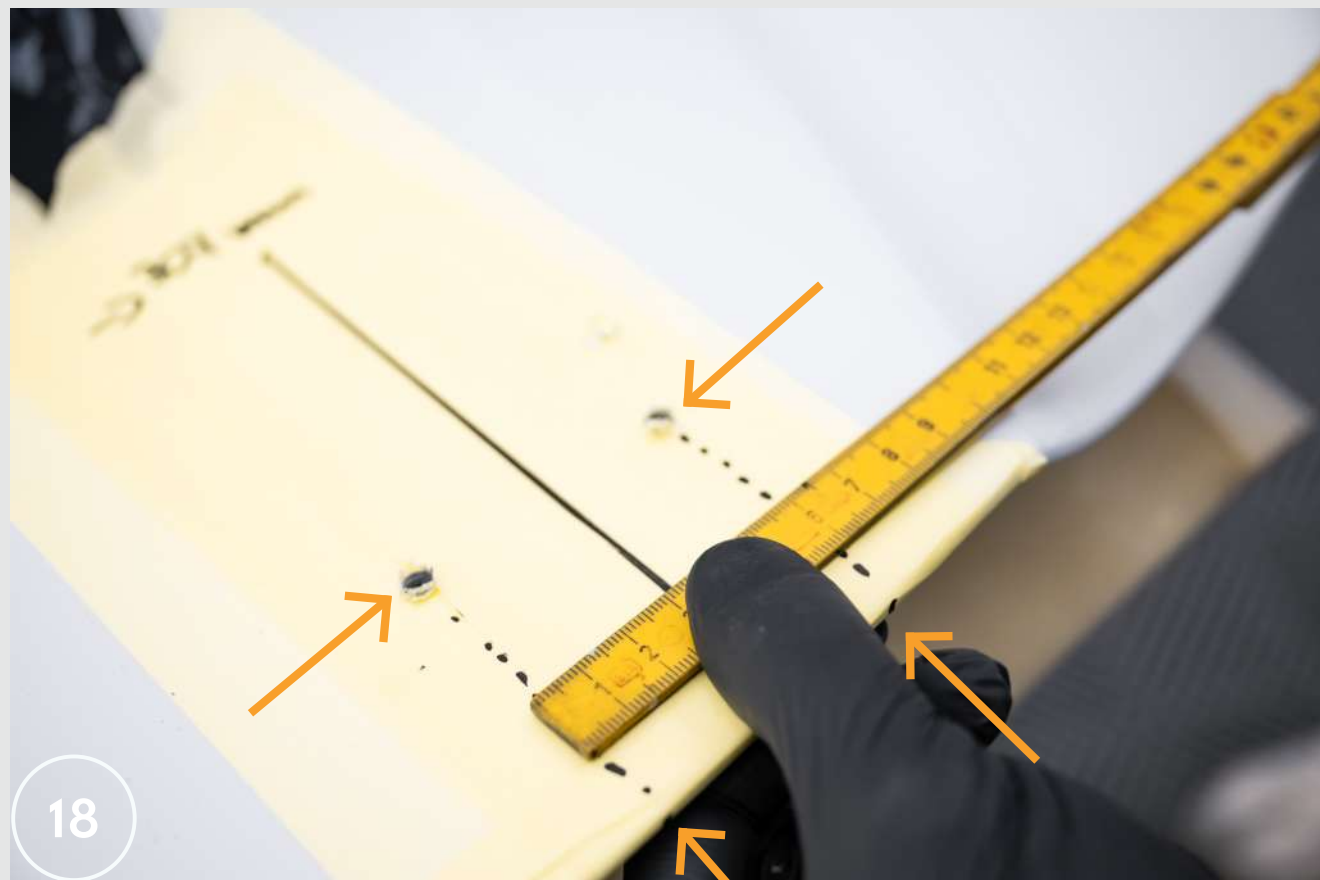

18



19



19



20





21



22

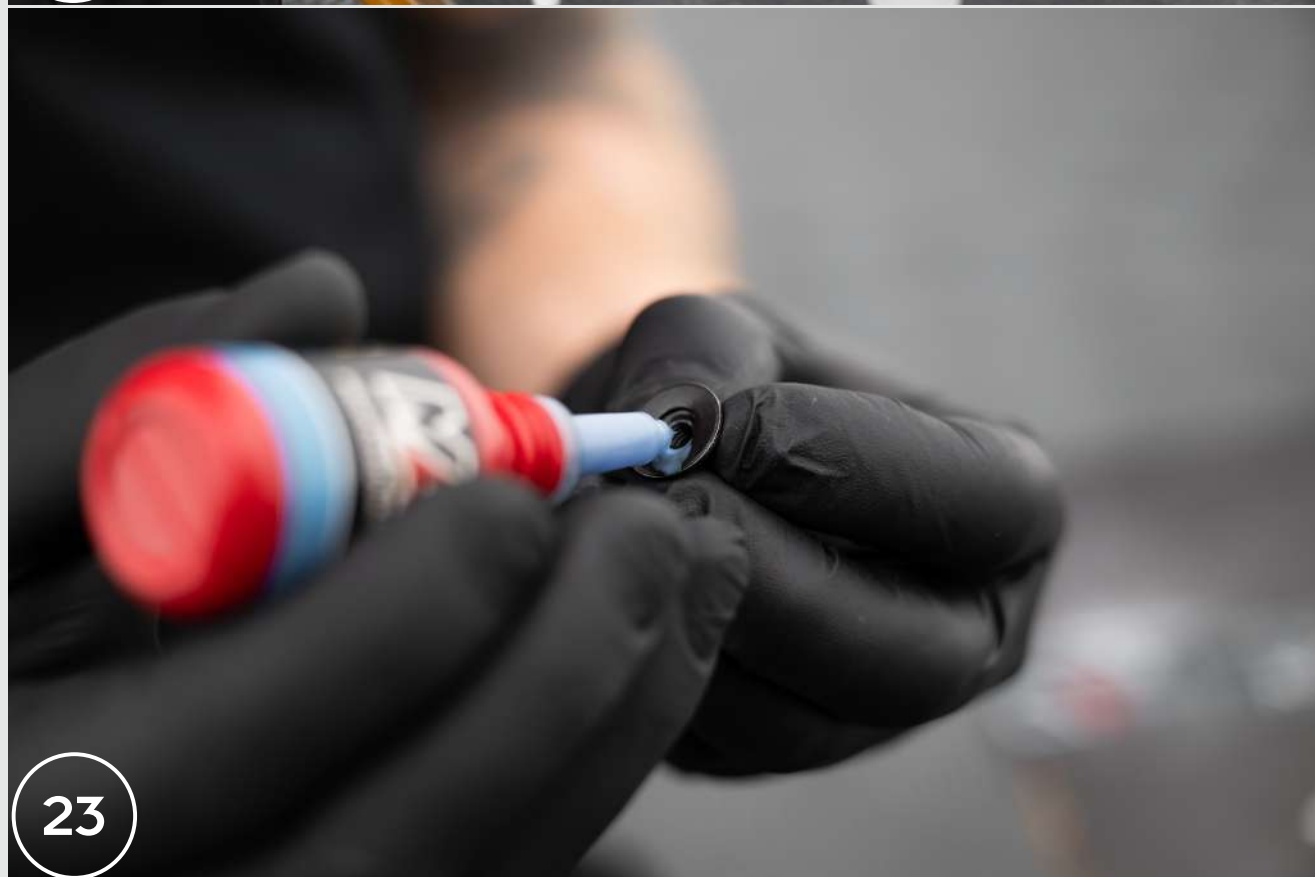

23

21. Glue the gasket to the carbon mount.

22. Place the carbon mount with the gasket on the tailgate in line with the holes.

23. Apply anti-loosening glue to the mounting screws.

24. Screw the carbon mount to the tailgate.

25. When screwing the mounting screws in place of the mounting insert, we recommend heating this element to harden it.

Attention! This operation should be done with due care so as not to damage this element.



24



24



24



25





26

26. After heating the mounting insert, tighten the mounting screws.



27

27. Tighten the mounting screws to a force of 6 Nm. Repeat the operation on the other side of the tailgate.

28. Lightly screw the spoiler bow to the installed carbon mount.

29. Screw the spoiler brackets to the spoiler.

30. Pull the LED power cable through the drilled hole.

31. Place the spoiler and brackets on the tailgate. Screw the spoiler brackets to the tailgate using the holes drilled on the edge of the tailgate.

If there are differences in the positions of the mounting holes and the drilled holes, we recommend enlarging the drilled holes so that the spoiler brackets rest completely on the tailgate.



28

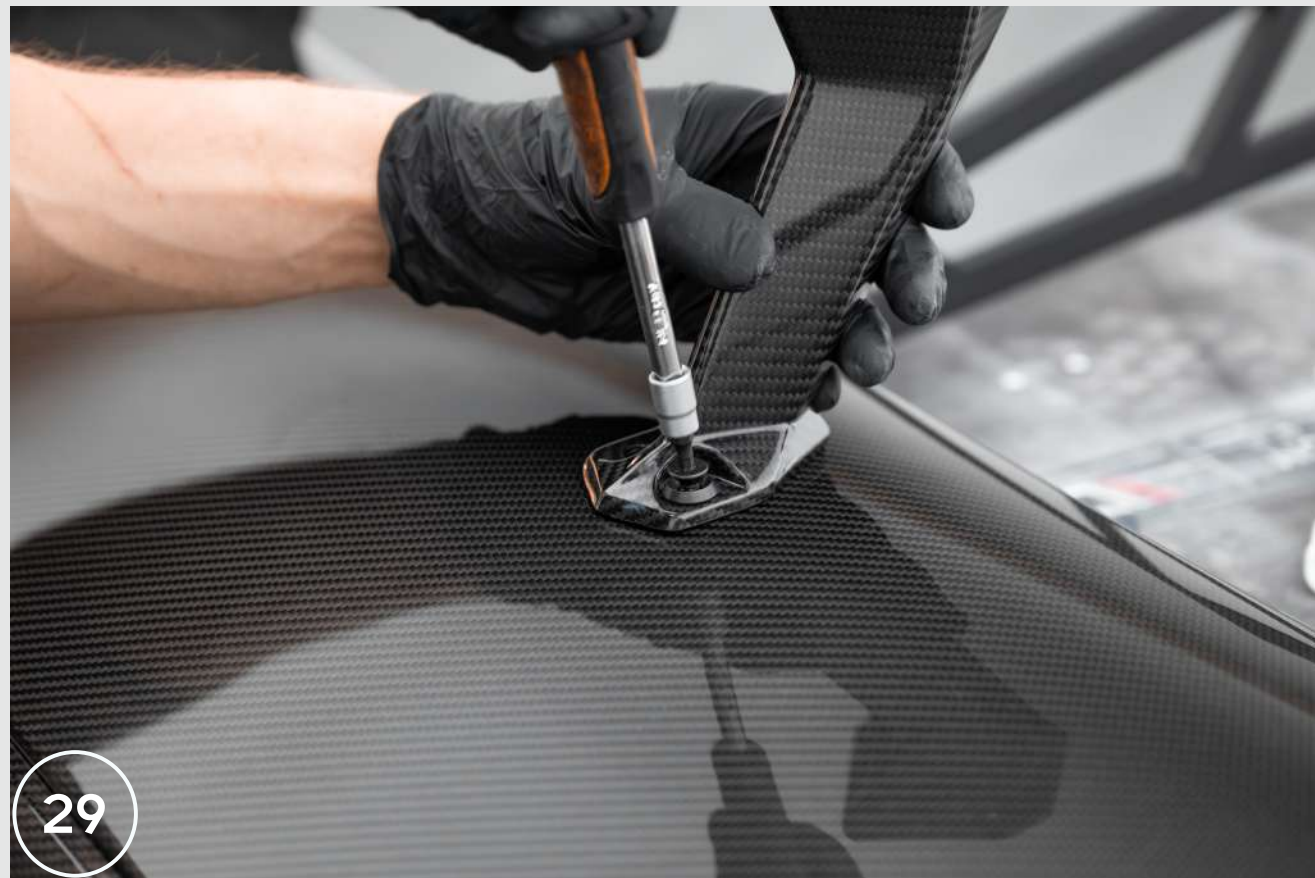

29



30



31



31



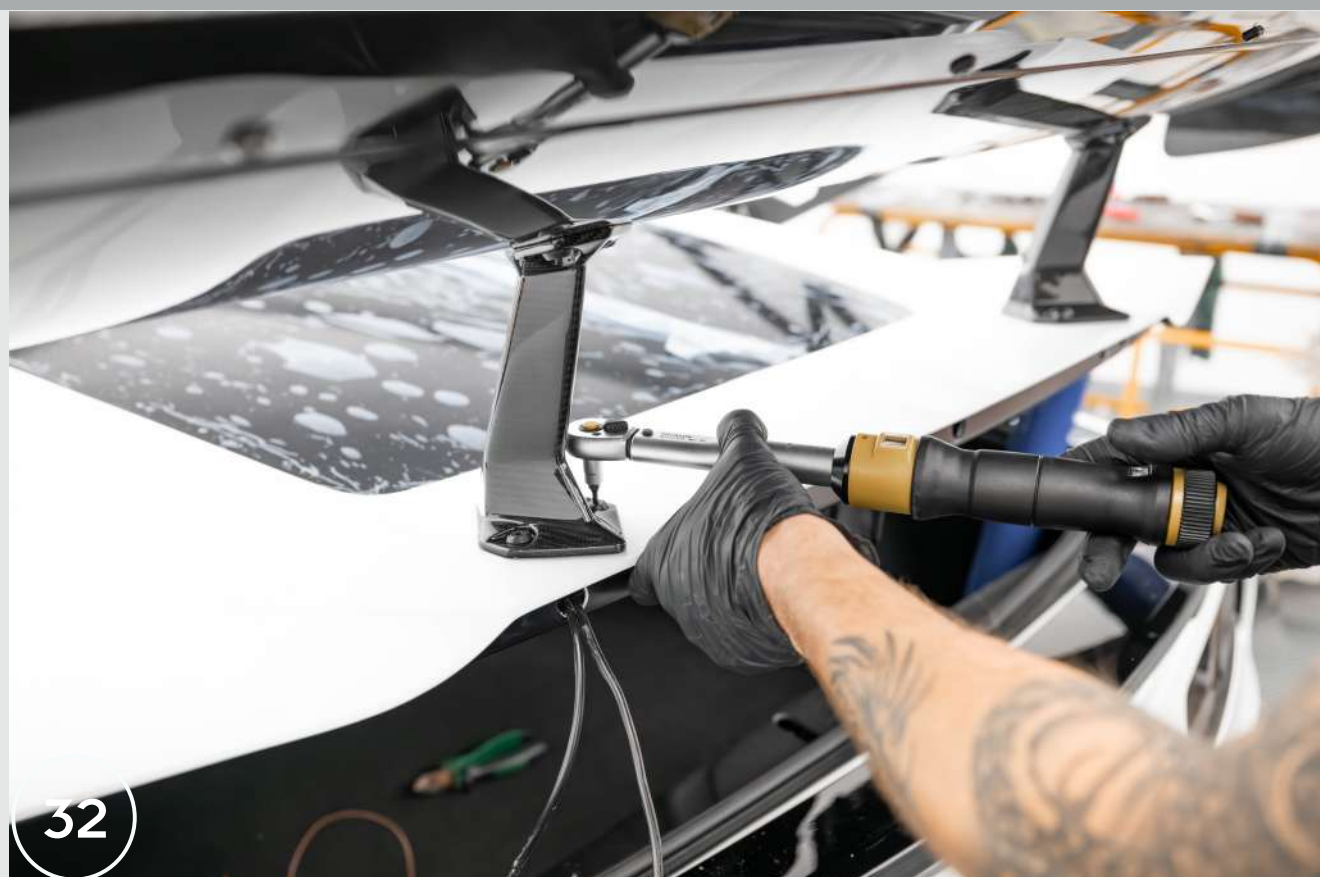

32. Tighten the mounting screws to a force of 6 Nm.

33. Secure the LED power cable.

34. Place the hole plugs in the edge of the tailgate.

35. Ready.



+48 14 307 06 04



sales@maxtondesign.eu

Video assembly  
instructions





